

2017 CATALOG

KING MARINE

COLUMBIA, NORTH CAROLINA

MARYSVILLE, WASHINGTON



Quality Marine Hardware

Tired of bending tube the hard way? We offer...

The KING BENDER...

A Manually Operated Tubing Bender & Roller
Designed for the Boat Top Manufacturer

Tubing Crowner

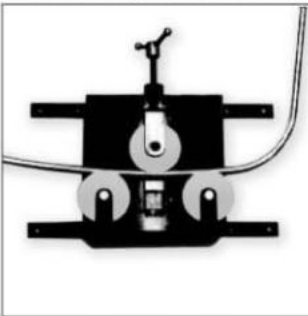

The Professional Bender

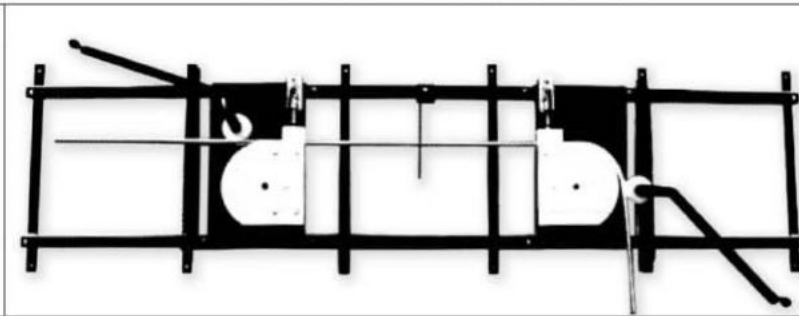

Tubing Bender

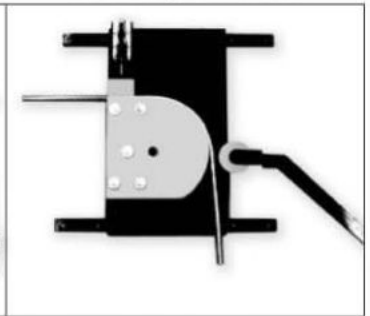

- Designed to roll aluminum or stainless steel tubing with adjustments.
- Welded steel base drilled with 1/2" holes with 16" and 24" centerline spacing to accommodate wall attachment.
- Made of #101 nylon plate using roller bearing inserts in nylon wheels.



- Designed to bend aluminum or stainless steel tubing with adjustments.
- Bends up to 95° with inside range of 6"
- Welded steel base drilled with 1/2" holes with 16" and 24" centerline spacing to accommodate wall attachment.
- Made of #101 nylon plate roll bearing inserts in nylon wheels.

ADVANTAGES of the KMI BENDER & ROLLER

- After predetermining the size of the boat top frame (leg and width sizes), each frame thereafter is consistent whether bending one or a thousand.
- Nylon parts are machined from #101 Nylon plate - a very tough but forgiving material that produces a superior finished product. Metal burrs, which can cause scratches, are not readily transferred from the Bender to the tubing. Also, the nylon is self lubricating.
- All rollers on both Bender & Crowner (Roller) have bearings to ensure easy operation for many years.
- The KMI Bender & Crowner is the first mass manufactured tool of its kind made especially for the Boat Top Industry. It works simply and eliminates the need for expensive tooling and extra operations. No more time consuming set up or need to use a follower.
- The KMI Bender & Crowner attaches to a wall - conserving space and allowing for easier operation.
- Welded heavy gauge steel frame.
- 7/8" Bender (will bend 3/4" and 7/8" OD tubing).
- 1" Bender (will bend 7/8" and 1" OD tubing).

TERMS AND CONDITIONS

PRICES: Subject to change without notice.

TERMS: Net 30 on approved credit or C.O.D.

ORDERS: King Marine will ship only full box orders
of tubing. We do not ship broken boxes.

RETURNS:

- ① No credit will be given for items returned without a return authorization (RGA) from King Marine.
- ② Restocking charges will be 15%.
- ③ **Must** be returned to the **same** warehouse from which it was shipped.
- ④ Must be packaged properly to prevent damage.

FREIGHT POLICIES: All freight will be shipped collect or as negotiated.

KING MARINE

WEST COAST DIVISION

3810 124th St. N.E.
Marysville, WA 98271-8775

EAST COAST DIVISION

3476 Albemarle Church Rd.
Columbia, NC 27925

Fax: (800) 283-6967 • E-Mail: info@kingmarine.com or www.kingmarine.com

ALUMINUM & STAINLESS STEEL TUBING

for the Boating Industry

Polished Stainless Steel Tube #304 (some #316)

Size	# Per Ft..	Per Box
7/8" x .035 Wall x 20' 2" or 24' 2"	.3141.....	30 pcs.
7/8" x .049 Wall x 20' 2" or 24' 2"	.452.....	30 pcs.
7/8" x .065 Wall x 20' 2" or 24' 2" or 30' 2"	.552.....	30 pcs.
1" x .049 Wall x 20' 2" or 24' 2"	.5102.....	25 pcs.
1" x .065 Wall x 20' 2", 24' 2" or 30' 2"	.639.....	25 pcs.
1-1/4" x .065 Wall x 20' 2" or 24' 2"	.793.....	16 pcs.
1-1/2" x .065 Wall x 20' 2"	.970.....	10 pcs.
2" x .065 Wall x 20' 2" or 24' 2"	1.300.....	8 pcs.
3" x .065 Wall x 20' 2"	2.040.....	3 pcs.
4" x .065 Wall x 20' 2"	2.736.....	3 pcs.

Brite Anodized Aluminum Tube

Size	# Per Ft..	Per Box
3/4" x .058 Wall x 20'	.149.....	54 pcs.
7/8" x .058 Wall x 20' / 24'	.175.....	38 / 18 pcs.
7/8" x .065 Wall x 20' / 24'	.195.....	38 / 18 pcs.
7/8" x .095 Wall x 20' / 24'	.274.....	38 / 18 pcs.
1" x .058 Wall x 20'	.202.....	28 pcs.
7/8" x 7/8" x .062 Wall x 6" (Mill)	.20.....	200 pcs.
1" x 1" x .062 Wall x 24' Satin	.198.....	28 pcs.

MANY other sizes in stock.

Tubing can be cut to size on large custom orders.

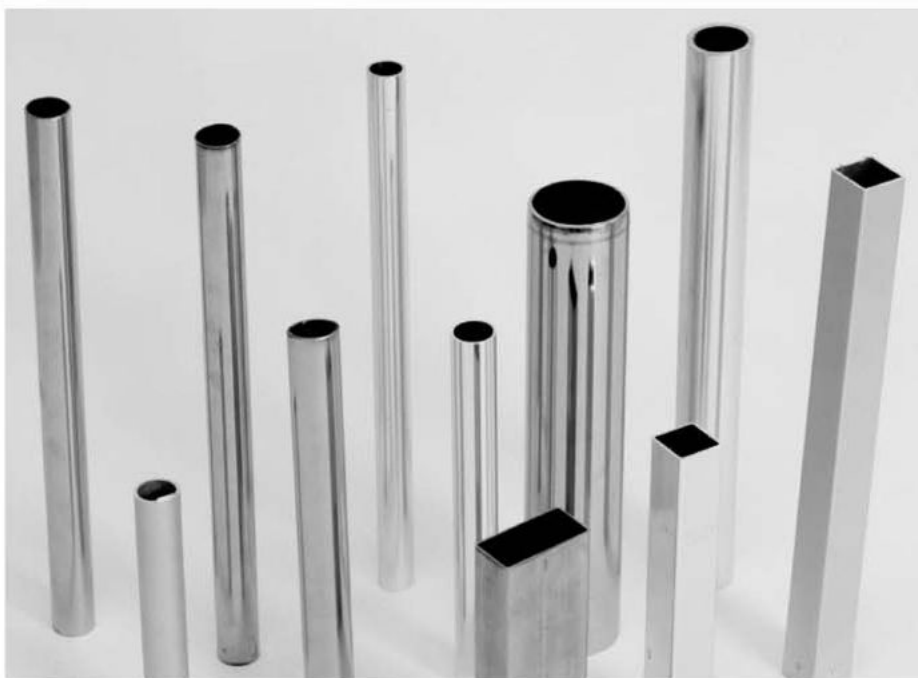

**INDEX**

ITEM	PAGE
Antenna Bases	7, 40
Bolt, Barrel	29
Bender / Crowner for Tubing	3
Bimini Top Hardware - 316 SS • Die Cast • Nylon	17 thru 26, 37 thru 40
Bimini Top Frames	46
Bow / Stern Eyes	27
Chocks - SS • Nylon	6, 40
Cleats - SS • Nylon	4 thru 5, 40
D-Rings	26
Deck Fills - Gas • Diesel • Waste • Water • Oil	30, 31
Drain Plugs - Garboard	35, 43
Drink / Cup Holders - SS • Nylon	36, 41
Fishing Rod Holders - SS • Nylon	32 thru 34, 40
Flag Pole Sockets	12
Fuel / Water Vents	29
Grab Rails / Hardware	12 thru 14, 34
Hasp	29
Hawse Pipe / Rope Deck Pipe	6 thru 8
Hooks / Snap Hooks	23, 36, 38
Hinges - Strap • Butt • Motor Box • Piano • etc.	27, 28, 45
Latches	35
Lift Rings / Handles	8, 35
Quick Release Pins / Cables	24, 25
Rail Hardware - Mechanical • Weldable	9 thru 15, 18
Rod Holders - SS • Nylon	32 thru 34, 40
Roller Bushings - Nylon	41
Scupper - Nylon	43
Ski-Tow	10
Step - Folding	9
Support Poles / Hardware	44
Seat Hardware - Hinges • Arm Support • Back Support	45
Thru-Hull - SS • Nylon with SS Cap	16
Thru-Hull Scupper - SS	16
Track - Aluminum • Nylon • Awning • Slide • Insert	45
Trailer Hitch Balls - 1-7/8" • 2" • 2-5/16"	36
Tubing - Aluminum • Stainless Steel • Tubing Crimper	2, 36
Vents - Gas • Water • Engine • Collector Boxes	29, 43
Windshield Hardware - Nylon	41, 42
Zipper Stops	25

MARINE HARDWARE - 316 STAINLESS STEEL

PULL UP CLEATS with Backing Plates, Nuts, White Gasket - Patented

88234-2 Cleat: 4-3/8" Flange: 1-1/2" wide x 5" long

(20 pcs per pkg) 26#

Drill 2 holes 7/8" and 2 holes 7/16"

Studs: 5/16" x 1-1/2" long

Use backing plate for hole template

White gasket included



88235-2 Cleat: 6" Flange: 1-7/8" wide x 7" long

(20 pcs per pkg) 38#

Drill 2 holes 1" and 2 holes 7/16"

Studs: 5/16" x 2-1/4" long

White gasket included

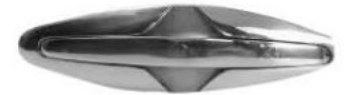

88236-2 Cleat: 8" Flange: 2-1/8" wide x 9" long

(10 pcs per pkg) 32#

Drill 2 holes 1-1/8" and 2 holes 11/16"

Studs: 3/8" x 2" long

White gasket included



CLEATS

88234 Size: 4-1/2" long x 1-1/4" wide x 1" high

(50 pcs per pkg) 15#

Drilled for #10 fasteners

88235 Size: 6" long x 1-7/8" wide x 1-1/4" high

(50 pcs per pkg) 22#

Drilled for 1/4" fasteners

88236 Size: 8" long x 2-1/8" wide x 1-1/2" high

(40 pcs per pkg) 29#

Drilled for 1/4" fasteners

88237 Size: 10" long x 2-3/4" wide x 1-7/8" high

(25 pcs per pkg) 42#

Drilled for 5/16" fasteners

88238 Size: 12" long x 2-3/4" wide x 2-5/16" high

(20 pcs per pkg) 50#

Drilled for 5/16" fasteners



HEAVY DUTY CLEATS

88239 Size: 8" long x 2-9/16" wide x 2" high

(40 pcs per pkg) 51#

Drilled for 1/4" fasteners

88240 Size: 10" long x 2-7/8" wide x 2-7/16" high

(20 pcs per pkg) 54#

Drilled for 5/16" fasteners

88241 Size: 12" long x 3-1/2" wide x 2-3/4" high

(10 pcs per pkg) 47#

Drilled for 5/16" fasteners

88242 Size: 14-3/4" long x 4" wide x 3-7/8" high

(10 pcs per pkg) 6.364#

Drilled for 1/2" fasteners



MARINE HARDWARE - 316 STAINLESS STEEL
SKENE BOW CHOCK SETS

88245 Length: 4-1/2", Width: 3/4", Line size: up to 1/2"

(50 pr per pkg) 30# Drilled for #10 screws

88245-9 Length: 9", Width: 1-3/4", Line size: up to 1-3/8"

(5 pr per pkg) 32# Drilled for 3/8" screws

88246 Length: 6", Width: 3/4", Line size: up to 3/4"

(20 pr per pkg) 29# Drilled for 1/4" screws

BOW CHOCK SETS

88247 Length: 4-3/4", Width: 1-1/8", Line size: up to 1/2"

(50 pr per pkg) 27# Drilled for #10 screws

88248 Length: 6", Width: 1", Line size: up to 3/4"

(25 pr per pkg) 32# Drilled for 1/4" screws

STRAIGHT CHOCKS

88249 Length: 4-7/8", Width: 7/8", Line size: up to 5/8"

(50 pcs per pkg) 23# Drilled for #10 screws

88250 Length: 6", Width: 1", Line size: up to 3/4"

(50 pcs per pkg) 32# Drilled for 1/4" screws

HAWSE PIPE

88252 Internal hole diameter: 3-3/4" x 1-1/2"

(25 pcs per pkg) 24# Length: 5-1/2", Width: 2-1/2", Depth: 7/8", below flange

Installation hole size: 4-1/8" x 2" (oval)

Drilled for #10 screws

HAWSE PIPE

88253 Internal hole diameter: 2" x 4"

(20 pcs per pkg) 25# Length: 6", Width: 3-1/4", Depth: 1-3/16", below flange

Installation hole size: 2-3/8" x 4-1/2"

Drilled for #10 screws

HAWSE PIPE

88253-1 Internal hole diameter: 7" x 3"

(10 pcs per pkg) 24# Length: 9.4", Width: 5-1/2", Depth: 1", below flange

Installation hole size: 3-3/4" x 7-3/4"

Drilled for 1/4" screws



MARINE HARDWARE - 316 STAINLESS STEEL

HAWSE PIPE

88254 Internal hole diameter: 1-1/2" x 4-1/2"
 (10 pcs per pkg) 24# Length: 7", Width: 4", Depth: 2-1/8", below flange
 Installation hole size: 2-1/2" x 4-1/2"
 Drilled for 1/4" screws



TRIANGLE HAWSE PIPE

88254-1 Internal hole diameter: 2-3/4" x 4-3/4"
 (10 pcs per pkg) 27# Length: 8", Width: 5-1/8", Depth: 1-3/4"
 Installation hole size: Irregular 4-3/4" x 2-3/4"
 Drilled for #10 screws



ANTENNA MOUNT HEAVY DUTY

88258 Base: 2" x 3-1/2"
 (20 pcs per pkg) 30# Overall Height: 5"
 Threads: 1-14 UNS2A
 Drilled for 1/4" bolts



ANTENNA MOUNT SUPER HEAVY DUTY

88256 Base: 2-1/4" x 3-3/4" • Overall Height: 6"
 (20 pcs per pkg) 45# Threads: 1-14 UNS2A
 Drilled for 1/4" bolts



ANTENNA RAIL MOUNT

88257 Length: 10"
 (25 pcs per pkg) 20# Fits 7/8" and 1" Tube Railing
 Threads: 1-14 UNS2A



MARINE HARDWARE - 316 STAINLESS STEEL

LIFT RING/CLEAT COMBINATION

88260 Maximum load: 4000 lbs.
 Length: 6", Eye diameter: 1-1/8"
 Base diameter: 2"
 Height: 2", Installation hole size: 1"
 Drilled for #10 screws
 For threaded rod size: 5/8"-11



LIFT RING

88745 Height from deck: 2-5/8" • Maximum load: 3000 lbs.
 (25 pcs per pkg) 28# Ring diameter: 1-1/2"
 Base diameter: 2-1/4"
 Hole size: 1-1/4"
 Drilled for #10 fastener • Threaded for rod size 5/8"-11



88746 Height from deck: 2-1/2" • Maximum load: 3000 lbs.
 (25 pcs per pkg) 35# Ring diameter: 1-1/2"
 Base length: 5"
 Hole size: 1-1/8"
 Drilled for #10 fastener • Threaded for rod size 5/8"-11



ROPE/DECK PIPE

88255 Internal hole size: 2-1/2" x 3-3/4"
 (25 pcs per pkg) 45# Length: 5-5/8" Width: 4-1/8"
 Depth below flange: 7/16"
 Height above deck: 1-1/4"
 Drilled for #10 screws



MARINE HARDWARE - 316 STAINLESS STEEL

FOLDING STEP With Locking Spring

88251 Base: 2" x 4-5/8" Wt. 1.2 lbs.
 (20 pcs per pkg) 27# Step Size: 2" x 4-3/8"
 Protrusion - Closed: 1"
 Protrusion - Open: 4"
 Use 2 each 5/8" bolt fasteners



30° ROUND BASE

88263 For 7/8" O.D. tube
 (50 pcs per pkg) 26# Base O.D.: 2-1/2" • Drilled for #10 screws
 88264 For 1" O.D. tube
 (50 pcs per pkg) 29# Base O.D.: 2-7/8" • Drilled for 1/4" screws



45° ROUND BASE

88265 For 7/8" O.D. tube
 (50 pcs per pkg) 29# Base O.D.: 2-7/8" • Drilled for #10 screws
 88265-1 For 1" O.D. tube
 (50 pcs per pkg) 32# Base O.D.: 2-7/8" • Drilled for 1/4" screws



60° ROUND BASE

88266 For 7/8" O.D. tube
 (50 pcs per pkg) 26# Base O.D.: 2-7/8" • Drilled for #10 screws
 88267 For 1" O.D. tube
 (50 pcs per pkg) 29# Base O.D.: 2-7/8" • Drilled for 1/4" screws



90° ROUND BASE

88268 For 7/8" O.D. tube
 (50 pcs per pkg) 24# Base O.D.: 2-7/8"
 Drilled for #10 screws
 88269 For 1" O.D. tube
 (50 pcs per pkg) 29# Base O.D.: 2-7/8"
 Drilled for 1/4" screws



30° RECTANGULAR BASE

88270 For 7/8" O.D. tube
 (50 pcs per pkg) 21# Base 3" x 1-3/4"
 Drilled for #10 screws
 88270-1 For 1" O.D. tube
 (50 pcs per pkg) 25# Base 3-1/2" x 1-3/4"
 Drilled for 1/4" screws



MARINE HARDWARE - 316 STAINLESS STEEL

45° RECTANGULAR BASE

88271 For 7/8" O.D. tube • Base: 3" x 1-3/4"

(50 pcs per pkg) 25# Drilled for #10 screws

88271-1 For 1" O.D. tube • Base: 3-1/4" x 1-3/4"

(50 pcs per pkg) 18# Drilled for 1/4" screws



60° RECTANGULAR BASE

88272 For 7/8" O.D. tube

(50 pcs per pkg) 26# Base: 3" x 1-3/4"

Drilled for #10 screws

88273 For 1" O.D. tube

(50 pcs per pkg) 25# Base: 3-1/4" x 1-7/8"

Drilled for 1/4" screws



90° RECTANGULAR BASE

88274 For 7/8" O.D. tube

(50 pcs per pkg) 23# Base: 2-7/8" x 1-3/4"

Drilled for #10 screws

88275 For 1" O.D. tube

(50 pcs per pkg) 25# Base: 3" x 1-7/8"

Drilled for 1/4" screws



SKI TOW RING SOLID CAST FACE / Washers and Nuts Included

88343 2-1/2" Ring, 2-1/2" Diameter

(25 pcs per pkg) 16# Overall length: 4-5/8" • Top to deck: 1-1/2"

Threads: 3" • 3/8" Round stock face, 3/4" stud

88343-1 3-1/2" Ring, 3-1/2" Diameter

(20 pcs per pkg) 27# Overall length: 5" • Top to deck: 1-5/8"

Threads: 3-3/4" • 1/2" Round Stock face, 7/16" stud



FLUSH SKI TOW SOLID CAST FACE / Full Washer and Lock Nuts

88343-2 Base: 4-7/16" wide x 2-7/16" high

(20 pcs per pkg) 26# Stud size: 3/8" studs x 2-3/4" long

Individually boxed



MARINE HARDWARE - 316 STAINLESS STEEL
90° RECTANGULAR BASE

88276	For 7/8" O.D. tube
(100 pcs per pkg) 30#	Base: 1-1/4" x 2-7/8"
	Drilled for 1/4" screws
88277	For 1" O.D. tube
(100 pcs per pkg) 25#	Base: 1-3/8" x 2-7/8"
	Drilled for 1/4" screws

60° UNIVERSAL TEE

88280	For 7/8" O.D. tube
(50 pcs per pkg) 39#	
88281	For 1" O.D. tube
(50 pcs per pkg) 44#	

90° TEE

88286	For 7/8" O.D. tube
(50 pcs per pkg) 31#	
88287	For 1" O.D. tube
(50 pcs per pkg) 34#	

90° TEE - HINGED

88286-2	For 7/8" O.D. tube
(50 pcs per pkg) 29#	

3 WAY CORNER ALL 90°

88288-1	For 7/8" O.D. tube
(50 pcs per pkg) 28#	
88288	For 1" O.D. tube
(50 pcs per pkg) 32#	

90° ELBOW WITH ANCHOR EYE

88308	For 7/8" tube
(50 pcs per pkg) 23#	
88307	For 1" tube
(50 pcs per pkg) 27#	

4° REC BASE LIFELINE STANCHION

88431	For 1" tube
(20 pcs per pkg) 23#	Base: "3 x 3-3/4"
	Drilled for 1/4" screws



MARINE HARDWARE - 316 STAINLESS STEEL
FLAG POLE SOCKET TOP MOUNTED

88357 For 1" post, 10° angle
 (50 pcs per pkg) 28# Base: 2-5/8" x 2-1/8" high
 Drilled for #10 screws

88364 For 1-1/4" post, 10° angle
 (50 pcs per pkg) 31# Base: 2-7/8" x 2-1/4" high
 Drilled for #10 screws

FLAG POLE SOCKET FLUSH MOUNTED

88367 For 1-1/4" post, 20° angle
 (25 pcs per pkg) 14# Base: 2-3/4" x 2-1/4" high
 Drilled for #10 screws

88367-1 For 1" post, 30° angle
 (50 pcs per box) 30-# Base: 2-3/4" x 2" high
 Drilled for #8 screws

88367-2 For 1-1/4" post, 20° angle
 (50 pcs per box) 40# Base: 2-7/8" x 2-1/4" high
 Drilled for #8 screws

STANCHION EYE

88332 For 1" x .065 wall tube
 (100 pcs per pkg) 18#

STANCHION SLEEVE W/EYE

88334 For 1" O.D. tube
 (100 pcs per pkg) 20# Eye diameter: 5/16"

LIFELINE BASE

88283 Hole size: 3/8"
 (50 pcs per pkg) 21# Length: 2-3/8", Width: 1-1/2", Height: 1-1/8" Use #10 screws

END TOP MOUNTED 90°

88290 For 7/8" O.D. tube
 (40 pcs per pkg) 38# Height: 1-1/2" Drilled for 1/4" screws

88290-1 For 1" O.D. tube
 (40 pcs per pkg) 40# Height: 1-1/2" Drilled for 1/4" screws



MARINE HARDWARE - 316 STAINLESS STEEL
END BOTTOM MOUNTED 90°

88290-2	For 7/8" tube
(40 pcs per pkg) 40#	Height: 1-1/2" • Nut threaded for 1/4 - 28
88290-3	For 1" tube
(40 pcs per pkg) 44#	Height: 1-1/2" • Nut threaded for 1/4 - 28

FORWARD 60° STANCHION

88293	For 7/8" O.D. tube
(100 pcs per pkg) 29#	Tube Height: 1-1/2"
	Drilled for #10 screws
88293-1	For 1" O.D. tube
(100 pcs per pkg) 35#	Tube Height: 1-3/4"
	Drilled for #10 screws

CENTER 60° STANCHION

88294	For 7/8" O.D. tube
(100 pcs per pkg) 27#	Tube Height: 1-1/2"
	Drilled for #10 screws
88294-1 27#	7/8" - 88294 w/set screw
88295	For 1" O.D. tube
(100 pcs per pkg) 32#	Tube Height: 1-3/4"
	Drilled for #10 screws

AFT 60° STANCHION

88298	For 7/8" O.D. tube
(100 pcs per pkg) 29#	Tube Height: 1-1/2"
	Drilled for #10 screws
88299	For 1" O.D. tube
(100 pcs per pkg) 36#	Tube Height: 1-3/4"
	Drilled for #10 screws

90° STATION FOR 1 1/4" TUBE

88296	Height: 3-1/8"
(50 pcs per pkg) 48#	Base: Length 2-1/2", Width 2"
	Drilled for 1/4" screws
	Set screw 1/4"-20" Allen or a variety of nylon head set screws are available

BULLET END PLUG

88303	For 7/8" O.D. tube, .049 wall
(200 pcs per pkg) 21#	Length: 7/8"



MARINE HARDWARE - 316 STAINLESS STEEL

BOW FORMS

88304	(50 pcs per pkg) 34#	For 7/8" O.D. tube - 110 degree
88305-2	(50 pcs per pkg) 39#	For 1" O.D. tube - 110 degree
88305	(50 pcs per pkg) 36#	For 7/8" O.D. tube - 125 degree
88305-3	(50 pcs per pkg) 38#	For 1" O.D. tube - 125 degree
88305-1	(50 pcs per pkg) 33#	For 7/8" O.D. tube - 140 degree
88305-4	(50 pcs per pkg) 37#	For 1" O.D. tube - 140 degree



90° ELBOWS

88309	(100 pcs per pkg) 50#	For 7/8" O.D. tube
88310	(100 pcs per pkg) 36#	For 1" O.D. tube



5-1/2° RAIL END (END-IN)

88311	(50 pcs per pkg) 21#	For 7/8" O.D. tube Drilled for #10 screws
-------	----------------------	--



5-1/2° RAIL END (END OUT)

88312	(50 pcs per pkg) 21#	For 7/8" O.D. x 049 wall tube Drilled for #10 screws
-------	----------------------	---



16-1/2° RAIL END (END OUT)

88312-1	(50 pcs per pkg) 23#	For 7/8" O.D. x 049 wall tube Drilled for #10 screws
---------	----------------------	---



45° ROUND BASE FOR WELDING

88406	(24 pcs per pkg) 7#	For 7/8" O.D. tube Base: 2-3/4" diameter Drilled for 1/4" C.S. screws
88416	(24 pcs per pkg) 8#	For 1" O.D. tube Base: 3-1/8" diameter Drilled for 1/4" C.S. screws



MARINE HARDWARE - 316 STAINLESS STEEL
60° ROUND BASE FOR WELDING

88404	For 7/8" O.D. tube
(24 pcs per pkg) 8#	Base: 2-3/4" diameter
	Drilled for 1/4" C.S. screws

88414	For 1" O.D. tube
(24 pcs per pkg) 10#	Base: 3-1/8" diameter
	Drilled for 1/4" C.S. screws

90° ROUND BASE FOR WELDING

88402	For 7/8" O.D. tube
(24 pcs per pkg) 8#	Base: 2-3/4" diameter
	Drilled for 1/4" C.S. screws

88412	For 1" O.D. tube	.218#
(24 pcs per pkg) 10#	Base: 3-1/8" diameter	
	Drilled for 1/4" C.S. screws	

45° RECTANGULAR BASE FOR WELDING

88424	For 7/8" O.D. tube
(24 pcs per pkg) 8#	Base: 1-3/4" x 3-1/8"
	Drilled for #10 C.S. screws

88432	For 1" O.D. tube
(24 pcs per pkg) 8#	Base: 1-3/4" x 3-1/8"
	Drilled for #10 C.S. screws

60° RECTANGULAR BASE FOR WELDING

88422	For 7/8" O.D. tube.
(24 pcs per pkg) 8#	Base: 1-3/4" x 3-1/8"
	Drilled for #10 C.S. screws

88430	For 1" O.D. tube
(24 pcs per pkg) 8#	Base: 1-3/4" x 3-1/8"
	Drilled for #10 C.S. screws

90° RECTANGULAR BASE FOR WELDING

88420	For 7/8" O.D. tube
(24 pcs per pkg) 8#	Base: 1-3/4" x 3-1/8"
	Drilled for #10 C.S. screws

88428	For 1" O.D. tube
(24 pcs per pkg) 8#	Base: 1-3/4" x 3-1/8"
	Drilled for #10 C.S. screws



MARINE HARDWARE - 316 STAINLESS STEEL

THRU-HULL ALL SS CAST

	Hose Size	A	B	C	D	E	Drill Hole Size
88470 (40 pcs per pkg) 18#	5/8"	1.50"	.875"	1.70"	1.30"	.625"	7/8"
88471 (48 pcs per pkg) 30#	3/4"	1.50"	1.10"	1.70"	1.30"	.75"	7/8"
88472 (25 pcs per pkg) 17#	1"	2.00"	1.36"	1.70"	1.50"	1.00"	1-3/8"
88473 (25 pcs per pkg) 18#	1-1/8"	2.00"	1.30"	1.70"	1.70"	1.125"	1-3/8"
88474 (25 pcs per pkg) 31#	1-1/4"	2.70"	1.65"	1.80"	1.80"	1.25"	1-3/4"
88475 (20 pcs per pkg) 25#	1-1/2"	2.75"	1.87"	2.00"	1.80"	1.50"	1-3/4"
88476 (20 pcs per pkg) 38#	2"	2.40"	2.02"	2.00"	2.00"	2.00"	2-3/8"



THRU-HULL SCUPPER SS CAST - With RUBBER FLAP

	Hose Size	A	B	C	D	E	Drill Hole Size
88475-2 (20 pcs per pkg) 28#	1-1/2"	2.75"	1.80"	2.50"	1.35"	1.50"	1-3/4"
88476-2 (20 pcs per pkg) 41#	2"	2.40"	2.30"	2.30"	1.60"	2.00"	2-3/8"



THRU-HULL NYLON/FIBERGLASS With SS CAP (Do not use below water)

	Hose Size	A	B	C	D	E	Drill Hole Size
88470-1 (100 pcs per pkg) 15#	5/8"	1.65"	1.24"	1.70"	1.30"	.625"	1-1/4"
88471-1 (100 pcs per pkg) 15#	3/4"	1.65"	1.24"	1.70"	1.30"	.750"	1-1/4"
88472-1 (100 pcs per pkg) 20#	1"	1.90"	1.35"	1.70"	1.50"	1.00"	1-3/8"
88473-1 (100 pcs per pkg) 20#	1-1/8"	1.90"	1.35"	1.70"	1.70"	1.125"	1-3/8"
88474-1 (100 pcs per pkg) 20#	1-1/4"	2.55"	1.74"	2.00"	1.90"	1.25"	1-3/4"
88475-1 (100 pcs per pkg) 20#	1-1/2"	2.55"	1.74"	2.00"	1.90"	1.50"	1-3/4"



This drawing applies to both Stainless Steel and Nylon Thru Hull.

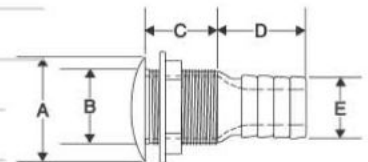

MARINE HARDWARE - 316 STAINLESS STEEL
OUTSIDE EYE END - Standard

88326 For 3/4" O.D. tube

(100 pcs per pkg) 17# For 1/4" bolt

88313 For 7/8" O.D. tube

(100 pcs per pkg) 24# For 1/4" bolt

88314 For 1" O.D. tube

(100 pcs per pkg) 25# For 1/4" bolt

OUTSIDE EYE END (COUNTER BORED)

88326 CB For 3/4" tube • For 1/4" bolt

(100 pcs per pkg) 19# Recessed for pop rivit

88313 CBC For 7/8" tube • For 1/4" bolt

(100 pcs per pkg) 24# Recessed for pop rivit

88314 CB For 1" tube • For 1/4" bolt

(100 pcs per pkg) 26# Recessed for pop rivit

JAW SLIDE (COUNTER BORED)

88316 CB For 7/8" tube • With 1/4" bolt

(100 pcs per pkg) 24# Recessed for pop rivit

88317 CB For 1" tube • For 1/4" bolt

(100 pcs per pkg) 28# Recessed for pop rivit

INSIDE EYE END

88344 Fits 3/4" x .049 tube • For 1/4" bolt

(200 pcs per pkg) 30#

88345 (200 pcs per pkg) 33# Fits 7/8" x .049 tube • For 1/4" bolt

88345-1 Fits 1" x .049 tube • For 1/4" bolt

(100 pcs per pkg) 20#

OUTSIDE EYE END HEAVY DUTY - 2 Set Screws

88396 For 7/8" tube

(100 pcs per pkg) 25# For 1/4" bolt

88397 For 1" tube

(100 pcs per pkg) 28# For 1/4" bolt

JAW SLIDE HEAVY DUTY - 2 Set Screws

88398 For 7/8" tube

(100 pcs per pkg) 26# With 1/4" bolt

88399 For 1" tube

(100 pcs per pkg) 29# With 1/4" bolt



MARINE HARDWARE - 316 STAINLESS STEEL
SPLIT RAIL FITTING - PATENTED

88365 (100 pcs per pkg) 40# 7/8" rail

88365N (100 pcs per pkg) 40# 7/8" rail drilled for 1/4" quick release pin

88366 (100 pcs per pkg) 42# 1" rail

The King Rail clamp is designed to quickly attach to an existing rail. It is hinged to open and close around a 1" or 7/8" Rail and comes with a locking screw and a 1/4" bolt. Patent #5413063.

LOCKING, HINGED RAIL/JAW CLAMP (5/16" HD Pin)

88365-1 (100 pcs per pkg) 38# Fits 7/8" rail 5/16" slot

88366-1 (100 pcs per pkg) 38# Fits 1" rail 5/16" slot

88366-2 (100 pcs per pkg) 44# Fits 1-1/4" rail 5/16" slot

JAW SLIDE - Standard

88315 For 3/4" O.D. tube
(100 pcs per pkg) 17# 1/4-20 panhead screw included

88316 For 7/8" O.D. tube
(100 pcs per pkg) 24# 1/4-20 panhead screw included

88317 For 1" O.D. tube
(100 pcs per pkg) 28# 1/4-20 panhead screw included

88316N For 7/8" O.D. tube
(100 pcs per pkg) 23# 1/4" hole drilled without pin

88317N For 1" O.D. tube
(100 pcs per pkg) 29# 1/4" hole drilled without pin

CLEVIS JAW SLIDE CAST

88330 For 7/8" tube
(100 pcs per pkg) 20# With 1/4" bolt

88319 For 1" tube
(100 pcs per pkg) 22# With 1/4" bolt

STAMPED JAW SLIDE WITH FULL BLACK VINYL GASKET

88395 For 7/8" O.D. tube
(100 pcs per pkg) 17# (no rattle)

88394 For 1" O.D. tube.
(100 pcs per pkg) 18# (no rattle)



MARINE HARDWARE - 316 STAINLESS STEEL
JAW SLIDE - DOUBLE SIDE

88317-2 For 1" O.D. tube
 (100 pcs per pkg) 40# 2 1/4" panhead screws
 1/4" set screw
 Thru hole for 1/4" Q.R. pin



OUTSIDE EYE END - HEAVY DUTY - For 1-1/4" Tube - 2 Set Screws

88328 Hole for 5/16" bolt
 (100 pcs per pkg) 51#

JAW SLIDE - HEAVY DUTY - For 1-1/4" - 2 Set Screws

88329 For 1-1/4" tube with 5/16" bolt
 (100 pcs per pkg) 38# 5/16" flush head bolt

HIGH DECK HINGE - HEAVY DUTY - For 1-1/4" (Use with 88328 Eye End)

88320-3 Base 1" x 2" x 3" high 4 Holes 
 (100 pcs per pkg) 32# Flush head screw 5/16"
 Drilled for #10 screws

EXTRA HEAVY DUTY OUTSIDE EYE END

88314-1 For 1" tube
 (100 pcs per pkg) 29# For 5/16" bolt

EXTRA HEAVY DUTY JAW SLIDE

88317-1 For 1" tube
 (100 pcs per pkg) 42# With 5/16" bolt

EXTRA HEAVY DUTY 90° DECK HINGE

88320-2 1" x 2-1/8"
 (100 pcs per pkg) 26# With 5/16" bolt • Drilled for 1/4" screws

PAD EYE, CAST

88545 Length: 1-7/8" Height: 5/8" • Drilled for #10 screws
 (100 pcs per box) 5#

PAD EYE, FORMED

88542 Length: 1-7/8" Height: 1/2" • Drilled for #8 screws
 (100 pcs per box) 5#



MARINE HARDWARE - 316 STAINLESS STEEL
DECK HINGE SIDE MOUNT

88323 Base size: 7/8" x 2"
 (200 pcs per pkg) 33# Panhead screw: 1/4-20
 Drilled for #10 screws

DECK HINGE SIDE MOUNT 25° BASE

88324 Base size: 7/8" x 2"
 (100 pcs per pkg) 29# Panhead screw: 1/4-20
 Drilled for #10 screws

316 S.S. 180° UNIVERSAL DECK HINGE (Heavy Duty Hinge Pin)

88323-1 2-5/8" long x 13/16" wide x 1-5/8" high
 (100 pcs per pkg) 28# Drilled for #10 screws

HEAVY DUTY DECK HINGE PLATE

88327 Base size: 1-7/8" x 2-3/4" • Bolt size: 1/4-20
 (100 pcs per pkg) 30# Drilled for 1/4" screws
 88327-1 Base size: 1-7/8" x 2-3/4" • Bolt size: 5/16"
 (100 pcs per pkg) 19# Drilled for 1/4" screws

90° DECK HINGE

88320 Base size: 3/4" x 2"
 (100 pcs per pkg) 19# Panhead screw 1/4" x 20" • Drilled for #10 screws
 88320-N Base size: 3/4" x 2"
 (100 pcs per pkg) 19# 1/4" drilled hole (pin not included) • Drilled for #10 screws

RAIL HINGE CONCAVE BASE

88321 Base size: 7/8" x 2"
 (100 pcs per pkg) 21# Panhead screw: 1/4" x 20"
 Drilled for #10 screws
 88321-N Base size: 7/8" x 2"
 (100 pcs per pkg) 20# 1/4" drilled hole (pin not included) Drilled for #10 screws

DECK HINGE ANGLE BASE

88322 Base size: 3/4" x 2"
 (100 pcs per pkg) 23# Panhead screw: 1/4 x 20" Drilled for #10 screws
 88322-N Base size: 3/4" x 2"
 (100 pcs per pkg) 20# 1/4" drilled hole (pin not included) Drilled for #10 screws



MARINE HARDWARE STAINLESS STEEL
DECK HINGE - ANGLE BASE 40° 316 SS

88322-2 Base size: 1" x 2-1/2"
 (100 pcs per pkg) 25# 1/4" drilled hole (pin not included)
 Drilled for #10 screws

SIDE MOUNT 316 SS

88323-2 90° concave base
 (100 pcs per pkg) 20# 2-3/8" long
 Drilled for #10 screws



88323-3 75° concave base
 (50 pcs per pkg) 20# 2-3/8" long
 Drilled for #10 screws

LARGE BLACK NYLON KNOB 304 SS

6425 Size: 1/4-20" x 1-1/2"
 (400 pcs per pkg) 23# Fits all SS die cast boat top hardware using 1/4-20"

ROUND NYLON HEAD Black or White 304 SS

7424P Size: 1/4-20" x 1" (Add B or W for color)
 (2,000 per box) 40# Fits all SS and die cast hardware using 1/4-20" screws

BLACK NYLON ELONGATED KNOB 304 SS

6426B Head: 1/2" x 1"
 (2,000 per box) 43# Screw: 13/16" (3/8" shaft, 7/16" thread)
 Fits all SS and die cast top hardware that uses 1/4-20" screws.

SMALL NYLON KNOB WITH SCREW, SWIVEL 6" CABLE 304 SS

88451 White Knob - 1/4-20" x 3/4" (3/8" shaft, 3/8" thread) (SS)
 (1,000 per box) 36# Use with S.S. deck hinges and jaw slides
 88452 Black Knob - 1/4-20" x 3/4" (3/8" shaft, 3/8" thread) (SS)
 (1,000 per box) 37# Use with deck hinges and jaw slides

SET SCREW (For S.S. and Die Cast Hardware) 304 SS

88338 1/4 - 28" x 3/16" pointed
 (100 pcs per pkg) 2# allen drive stainless steel

PAN HEAD SHOULDER SCREW (For S.S. and Die Cast Hardware) 304 SS

88450 Fits 3/4", 7/8" and 1" Jaw Slides and Deck Hinges
 (100 pcs per pkg) 4#



MARINE HARDWARE - 316 STAINLESS STEEL

FLAT HINGE w/ HIDDEN SCREWS

88333	Base : 5/8" x 1-5/8"
(100 pcs per pkg) 21#	Panhead screw 1/4" x 20" • Drilled for #10 screws
88333 N	Base : 5/8" x 1-5/8"
(100 pcs per pkg) 19#	1/4" drilled hole • Drilled for #10 screws
88336	Adapter pad for 88333/88333 N
(100 pcs per pkg) 10#	Base: 5/8" x 1-5/8" • Drilled for #10 screws



RAIL HINGE w/ HIDDEN SCREWS

88331	Base : 5/8" x 1-5/8"
(100 pcs per pkg) 25#	Panhead screw: 1/4" x 20"
	Drilled for #10 screws
88331 N	Base : 5/8" x 1-5/8"
(100 pcs per pkg) 23#	1/4" drilled hole (pin not included)
	Drilled for #10 screws



QUICK RELEASE SIDE MOUNT / EYE END SET

88306	Fits 7/8 " x .049" tube
(100 pcs per pkg) 48#	Drilled for #10 O.H. fastener



MARINE HARDWARE - DIE CAST ZAMAK

OUTSIDE EYE END

86000 For 7/8" O.D. tube
 (100 pcs per pkg) 20# For 1/4" bolt



90° DECK HINGE

86002 Base size: 7/8" x 2"
 (100 pcs per pkg) 20# Panhead screw 1/4" x 20" • Drilled for #10 screws



86002N Base size: 7/8" x 2"
 (100 pcs per pkg) 20# 1/4" drilled hole (pin not included) • Drilled for #10 screws



JAW SLIDE

86004 For 7/8" O.D. tube
 (100 pcs per pkg) 22# With 1/4" bolt



PAD EYE

86006 Length: 1-7/8"
 (100 per box) 5# Height: 5/8"
 Drilled for #10 screw



DECK HINGE SIDE MOUNT

86008 Base size: 7/8" x 2"
 (100 pcs per box) 14# Panhead screw: 1/4"-20
 Drilled for #10 screws



INSIDE EYE END

86010 For 7/8" x .058"
 (400 pcs per pkg) 15# For 1/4" bolt



ALL OF THE ABOVE PRODUCTS ARE CHROME-PLATED DIE CAST

MARINE HARDWARE - 304 STAINLESS STEEL

QUICK RELEASE PIN 304 SS

- 88453 (1,000 per box) 44# 1/4" O.D. with 2-1/8" grip
- 88546 (1,000 per box) 25# 1/4" O.D. with 7/8" grip
- 88544 (1,800 per box) 58# 1/4" O.D. with 1.3" grip
- 88554 (650 per box) 63# 1/4" O.D. with 5.5" grip



QUICK RELEASE PIN WITH DROP CAM AND SPRING 304 SS

- 88551 (1,000 per box) 32# 1/4" O.D. with 3/4" grip
- 88551-1 (1,000 per box) 37# 1/4" O.D. with 1" grip



QUICK RELEASE PIN WITH CABLE AND NO TAB 304 SS

- 88561-1 (1,000 per box) 40# 1/4 O.D. with 1" grip
6" cable - loop end



QUICK RELEASE PIN WITH CABLE AND TAB 304 SS

- 88547 (1,000 per box) 39# 1/4" O.D. with 7/8" grip
6" SS cable - nylon coated with tab



SS CABLE WITH TAB 304 SS

- 88543 (1,000 per box) 3# 6" nylon coated



QUICK RELEASE PIN WITH CABLE AND TAB 304 SS

- 88548 (100 pcs per pkg) 5# 1/4" O.D. with 3/4" grip
6" cable - nylon coated with tab



MARINE HARDWARE - 304 STAINLESS STEEL

QUICK RELEASE PIN WITH CABLE AND NO TAB

88555 1/4" O.D. with 2-1/4" grip
 (600 per box) 5# 6" SS cable - nylon coated



QUICK RELEASE PIN WITH CABLE AND EYE

88561 1/4" O.D. with 3/4" grip
 (100 per box) 5# 6" SS cable - nylon coated - with electrical eye end



SS CABLE WITH LOOPS

88556 1/4" O.D.
 (1,000 per pbox) 4# 6" cable clear coated



SS CABLE WITH LOOP AND EYE

88560 6" cable clear coated with electrical eye end
 (1,000 per box) 5#



SS KEY RING

88557 1" diameter
 (1,000 per box) 7#



QUICK RELEASE PIN WITH CABLE LOOP

88550 1/4" O.D. with 1" grip
 (100 pcs per pkg) 4# 3" dia. cable - nylon coated



CABLE LOOP ONLY

88553 3" dia. cable - nylon coated
 (1,000 pcs per box) 5#

SS ZIPPER STOPS (316 SS)

89001 For YKK Zippers - #10
 (1,000 per box) 26#



89002 For RIRI Zippers - #10
 (1,000 per box) 30#

MARINE HARDWARE - 316 STAINLESS STEEL
D RINGS

88998 1" x 3/16" Welded

(100 pcs per pkg) 2#



88999 1-1/2" x 3/16" Welded

(100 pcs per pkg) 4#

ADJUSTER BUCKLE

89000 For 1" webbing

(100 pcs per pkg) 2#

SNAP HOOK

89005 For 1" webbing

(100 pcs per pkg) 3# Overall length: 2-1/8"

FAST EYE HEAVY DUTY SNAP HOOK Cast Chrome Plated Brass

89006 Overall length 2"

(100 pcs per pkg) 6# Dia. inside 1/4" x 1"

For 1" webbing

FAST EYE HEAVY DUTY SNAP HOOK

89007 Cast 316 Stainless Steel

(100 pcs per pkg) 6# Overall length 2"

Dia. inside 1/4" x 1"

For 1" webbing

FENDER HOOK

89010 Length: 1" Width: 1-1/4"

(100 pcs per pkg) 2# Mounting hole diameter: 3/16" CS



MARINE HARDWARE - 316 STAINLESS STEEL
U BOLT BOW AND STERN EYE

88341	Eye is made from 5/16"	5,000#
(40 pcs per pkg) 32#	S.S. stock with <u>rolled</u> threads	5/16"-18"
	Overall length is 4-1/4" with thread length: 3"	
88342	Eye is made from 7/16"	10,000#
(40 pcs per pkg) 59#	S.S. stock with <u>rolled</u> threads	7/16"-14"
	Overall length is 5-1/2" with thread length: 3-1/4"	
88342-1	Eye is made from 5/8"	12,000#
(40 pcs per pkg) 48#	S.S. stock with <u>cut</u> threads	5/8"-11"
	Overall length is 5-1/2" with thread length: 2-3/4"	
88342-2	Eye is made from 5/8"	12,000#
(30 pcs per pkg) 47#	S.S. stock with <u>cut</u> threads	5/8"-11"
	Overall length is 8" with thread length: 4-3/8"	

STRAP HINGES

88349	Size: 4" x 1" Open
(100 pcs per pkg) 20#	Drilled for #10 screws
88350	Size: 6" x 1-1/8" Open
(100 pcs per pkg) 27#	Drilled for #10 screws

BUTT HINGES

88351	Size: 1-1/2" x 1-1/2" Open
(100 pcs per pkg) 19#	Drilled for #10 screws
88352	Size: 2" x 2" Open
(100 pcs per pkg) 22#	Drilled for #10 screws

DOOR HINGES

88353	Size: 1-1/2" x 2-1/4" Open
(100 pcs per pkg) 17#	Drilled for #8 screws
88353-1	Size: 1-1/2" x 3" Open
(100 pcs per pkg) 21#	Drilled for #8 screws
88355	Size: 1-1/2" x 3"
(100 pcs per pkg) 20#	Drilled for #8 screws
88356	Size: 1-1/2" x 4" Open
(100 pcs per pkg) 30#	Drilled for #10 screws



MARINE HARDWARE - 316 STAINLESS STEEL

OFFSET HINGES

88358 Size: 1-1/2" x 2-1/4" Open
 (100 pcs per pkg) 21# Offset: 3/8"
 Drilled for #8 screws

88358-1 Size: 1-1/2" x 2-3/4" Open
 (100 pcs per pkg) 24# Offset: 3/8"
 Drilled for #10 screws



DOUBLE HINGE

88354 Size: 1-5/8" x 2-7/8" Open
 (100 pcs per pkg) 17# Drilled for #8 screws



TAKE APART MOTOR BOX HINGE (LOCKING)

88359 Size: 1-1/2" x 3-1/2" Open
 (100 pcs per pkg) 23# Drilled for #10 screws



TAKE APART MOTOR BOX HINGE (NON-LOCKING)

88359-1 Size: 1-1/2" x 3-1/2" Open
 (100 pcs per pkg) 40# Drilled for #10 screws



HATCH HINGE - STANDARD

88360 Size: 3" x 2-1/2" Open
 (50 pcs per pkg) 29# Drilled for #10 screws



HATCH HINGE - ANGLE

88360-1 Size: 3" x 2" x 2" For 90° mount
 (50 pcs per pkg) 25# Drilled for #10 screws



LONG ARM HINGE

88748 Opening gap: 1-3/8"
 (50 pcs per pkg) 33# 3" x 3-5/8" Open
 Drilled for #10 screws



MARINE HARDWARE - 316 STAINLESS STEEL

NOTE: ALL GAS FILLS DO NOT MEET JULY 2012 USCG SPECIFICATIONS

HOSE DECK FILLS WITH KEY - (All Have 20 Pcs Per Box)

88372 L 1-1/2" Hose Deck Fill, gas 20#	88376 L 1-1/2" Replacement Cap & Chain
88373 L 1-1/2" Hose Deck Fill, diesel 20#	88378 L 2" Hose Deck Fill, gas
88374 L 1-1/2" Hose Deck Fill, water 20#	88377 L 2" Hose Deck Fill, diesel
88375 L 1-1/2" Hose Deck Fill, waste 20#	88371 L 2" Hose Deck Fill, water
88375-5 1-1/2" Hose Deck Fill, waste w/2" top 22#	88370 L 2" Hose Deck Fill, waste
88369 L 1-1/2" Hose Deck Fill, oil 20#	88379 L 2" Replacement Cap & Chain
88380 L 1-1/2" and 2" Replacement Key 5#	



All deck fills use #10 fasteners

HOSE DECK FILL WITH KEY - 35° ANGLE - (All Have 20 Pcs Per Box)

88372-3 (20 pcs per pkg) 21#	1-1/2" Hose Deck Fill, gas • Use #10 fasteners
88373-3 (20 pcs per pkg) 21#	1-1/2" Hose Deck Fill, diesel • Use #10 fasteners
88374-3 (20 pcs per pkg) 21#	1-1/2" Hose Deck Fill, water • Use #10 fasteners
88375-3 (20 pcs per pkg) 21#	1-1/2" Hose Deck Fill, waste • Use #10 fasteners



HOSE DECK FILLS WITH SPLASH GUARD - (All Have 20 Pcs Per Box)

88372-2 (20 pcs per pkg) 20#	1-1/2" Deck Fill, gas • Use #10 fasteners
88376-2 (20 pcs per pkg) 20#	Replacement for Cap and Chain • Use #10 fasteners



PIPE DECK FILLS WITH KEY - (All Have 20 Pcs Per Box)

88372-1 (20 pcs per pkg) 22#	1-1/2" Pipe Deck Fill, gas • 1-1/2" high • Use #10 fasteners
88373-1 (20 pcs per pkg) 22#	1-1/2" Pipe Deck Fill, diesel • 1-1/2" high • Use #10 fasteners
88374-1 (20 pcs per pkg) 22#	1-1/2" Pipe Deck Fill, water • 1-1/2" high • Use #10 fasteners
88375-1 (20 pcs per pkg) 22#	1-1/2" Pipe Deck Fill, waste • 1-1/2" high • Use #10 fasteners



DECK FILL WITH BREATHABLE CAP

88100 (10 pcs per pkg) 36#	1-1/2" Hose Deck Fill, gas • Use #10 fasteners
88101 (10 pcs per pkg) 36#	1-1/2" Hose Deck Fill, diesel • Use #10 fasteners
88102 (10 pcs per pkg) 36#	1-1/2" Hose Deck Fill, water • Use #10 fasteners
88103 (10 pcs per pkg) 36#	1-1/2" Hose Deck Fill, waste • Use #10 fasteners



DECK FILL WITH BREATHABLE CAP 50° ANGLE

88105 (10 pcs per pkg) 35#	1-1/2" Hose Deck Fill, gas • Use #10 fasteners
88106 (10 pcs per pkg) 35#	1-1/2" Hose Deck Fill, diesel • Use #10 fasteners
88107 (10 pcs per pkg) 35#	1-1/2" Hose Deck Fill, water • Use #10 fasteners
88108 (10 pcs per pkg) 35#	1-1/2" Hose Deck Fill, waste • Use #10 fasteners



MARINE HARDWARE - 316 STAINLESS STEEL

NOTE: ALL GAS FILLS DO NOT MEET JULY 2012 USCG SPECIFICATIONS

DECK FILL WITH BREATHABLE CAP & INTERNAL VENT

- 88110 (10 pcs per pkg) 37# 1-1/2" Hose Deck Fill, gas • Use #10 fasteners
- 88111 (10 pcs per pkg) 37# 1-1/2" Hose Deck Fill, diesel • Use #10 fasteners
- 88112 (10 pcs per pkg) 37# 1-1/2" Hose Deck Fill, water • Use #10 fasteners



DECK FILL WITH BREATHABLE CAP & INTERNAL VENT 50° ANGLE

- 88115 (10 pcs per pkg) 38# 1-1/2" Hose Deck Fill, gas • Use #10 fasteners
- 88116 (10 pcs per pkg) 38# 1-1/2" Hose Deck Fill, diesel • Use #10 fasteners
- 88117 (10 pcs per pkg) 38# 1-1/2" Hose Deck Fill, water • Use #10 fasteners



REPLACEMENT BREATHABLE CAP

- 88120 (10 pcs per pkg) 8# 1-1/2" Hose Deck Fill, gas
- 88121 (10 pcs per pkg) 8# 1-1/2" Hose Deck Fill, diesel
- 88122 (10 pcs per pkg) 8# 1-1/2" Hose Deck Fill, water
- 88123 (10 pcs per pkg) 8# 1-1/2" Hose Deck Fill, waste



RUBBER 'O' RING REPLACEMENT

- 88124 (25 pcs per pkg) 2# Fits 88100 thru 88123



CHAIN REPLACEMENT WITH HD CONNECTORS

- 88124-1 Fits all deck fills
- (10 pkg minimum) 1# 8" long O/A



MARINE HARDWARE - 316 STAINLESS STEEL

FLUSH MOUNT ROD HOLDER - All have solid cast flange

88383 30° White Liner
 (20 pcs per pkg) 35# Oval flange: 3 3/8" x 4 1/4"
 2" Tube-drilled for #14 fasteners

88383-1 15° White Liner
 (20 pcs per pkg) 34# Oval flange: 3 3/8" x 4 1/4"
 2" Tube-drilled for #14 fasteners

88383-3 90° Vertical White Liner
 (20 pcs per pkg) 35# Oval flange: 3 3/8" x 4 1/4"
 2" Tube-drilled for #14 fasteners

88383-2 90° Vertical White Liner
 (20 pcs per pkg) 34# Round flange: 4 1/4"
 2" Tube-drilled for #14 fasteners



88385 30° Black Liner
 (20 pcs per pkg) 35# Oval flange: 3 3/8" x 4 1/4"
 2" Tube-drilled for #14 fasteners

88385-1 15° Black Liner
 (20 pcs per pkg) 34# Oval flange: 3 3/8" x 4 1/4"
 2" Tube-drilled for #14 fasteners

88385-2 90° Vertical Black Liner
 (20 pcs per pkg) 35# Oval flange: 3 3/8" x 4 1/4"
 2" Tube-drilled for #14 fasteners



88391 30° Black Liner, Cap/Gasket
 (20 pcs per pkg) 36# Oval flange: 3 3/8" x 4 1/4"
 2" Tube-drilled for #14 fasteners

88391-1 15° Black Liner, Cap/Gasket
 (20 pcs per pkg) 36# Oval flange: 3 3/8" x 4 1/4"
 2" Tube-drilled for #14 fasteners

88391-2 90° Vertical Black Liner, Cap/Gasket
 (20 pcs per pkg) 35# Oval flange: 3 3/8" x 4 1/4"
 2" Tube-drilled for #14 fasteners



MARINE HARDWARE - 316 STAINLESS STEEL

FLUSH MOUNT ROD HOLDER (continued)

88382 30° White Liner
 (20 pcs per pkg) 36# Square oval flange: 3 1/2" x 4 1/2"
 2" Tube-drilled for #14 fasteners



88389 30° Black Liner
 (20 pcs per pkg) 37# Square oval flange: 3 1/2" x 4 1/2"
 2" Tube-drilled for #14 fasteners

88383-4 30° White Liner Only
 (100 pcs per pkg) 29# Fits 88383/88382



88383-1-4 15° White Liner Only
 (100 pcs per pkg) 26# Fits 88393-1

88383-2-4 90° Vertical White Liner Only
 (100 pcs per pkg) 29# Fits 88383-1 and 88383-3

88391-4 30° Black Liner Only
 (100 pcs per pkg) 29# Fits 88391/88385



88391-1-4 15° Black Liner Only
 (20 pcs per pkg) 29# Fits 88391-1

88391-2-4 90° Vertical Black Liner Only
 (100 pcs per pkg) 30# Fits 88391-2

88392 30° Black Liner/Cap (1 piece)
 (100 pcs per pkg) 27# Fits 88391/88385



88391-5 Black Gasket - Cap Only
 (100 pcs per pkg) 3# Fits 88391, 88391-1, 88391-2, 88391-3



88390-2 Black Drain End Cap
 (100 pcs per pkg) 4# Fits 2" Tube - All "King" Flush Rod Holders



MARINE HARDWARE - 316 STAINLESS STEEL

2-WAY ADJUSTABLE PEDESTAL ROD HOLDER

88393 Length overall: 12"
 (10 pcs per pkg) 38# Base: 2-1/4" x 3-3/8"
 Drilled for 1/4" bolt



BULKHEAD MOUNT ROD HOLDER

88387 Length: 9-3/4"
 (10 pcs per pkg) 22# Tube size: 2"
 Wall: .060 • Drilled for 1/4" screws



ADJUSTABLE RAIL MOUNT ROD HOLDER

88388 Length: 9-3/4"
 (10 pcs per pkg) 19# Tube size: 2"
 Wall: .060
 Holder fits 7/8" and 1" rail



GRAB RAIL 304 SS Tube

89075 Length: 7-3/4" x 2-7/8" high
 Round 7/8" x .049 #304 SS • With 1/4-20 x 2" studs
 89012-2 10# Length 12" x 2-3/8" high (made in USA)
 89018 Length: 19-3/4" x 2-3/8" high
 Round 7/8" x .049 #304 SS • With 1/4-20 x 2" stud



MARINE HARDWARE - 316 STAINLESS STEEL
SMALL FLUSH LIFT RING

88362 Size: 1-1/2" x 1-15/16"
 (100 pcs per pkg) 11# Drilled for #8 screws

FLUSH LIFT HANDLE

88368 Length: 3" • Width: 2-1/4"
 (100 pcs per pkg) 34# below Flange: 1/4"
 handle o/a: 2-3/8"

HATCH LIFT RING - Latching with Gasket and Strikes

88302 2-3/8" OD
 (50 pcs per pkg) 26# Drill 2" hole
 Gasket, back plate, strikes and screws included

LOCKING HATCH LIFT RING - Latching with Gasket and Strikes

88302-1 2-3/8" OD
 (50 pcs per pkg) 28# Drill 2" hole
 Gasket, back plate, strikes, 2 keys and screws included

RECESSED RING COUNTER BALANCED TO 90°

88400 Length: 3"
 (100 pcs per pkg) 10# Width: 5/8"
 below Flange: 7/8"

TURN LATCH

88401 Diameter: 2-1/4"
 (100 pcs per pkg) 28# Height: 5/8"
 for #8 screws

BRASS GARBOARD DRAIN - CAST

86500-1 (50 pcs per pkg) 45# 2" Flange with 1/2" pipe plug • Drilled/countersunk for #8 screw
 86501-1 (400 pcs per pkg) 8# Plug only/with pin
 86503 (50 pcs per pkg) 38# Flange only (no plugs)

FISHING RIG/LURE HOLDER w/Locknuts and Washers

89020 316 S.S. - 3/8" rod
 (20 pcs per pkg) 8# 6" long x 1" installed
 1-1/4" Threaded shaft for 3/8" nut



MARINE HARDWARE - 316 STAINLESS STEEL

DRINK / CUP HOLDERS With Lock Nuts and Washers 316 SS

3/8" Solid cast rings / welded studs with 1-1/2" threads

All are 2-3/4" above deck - All rings are I/O

88002 (20 pcs per pkg) 15#	1 Ring • 4-1/4" x 4-1/8" long - mounts under deck
88004 (12 pcs per pkg) 14#	2 Ring • 4-1/4" x 8-1/8" long - mounts under deck
88006 (12 pcs per pkg) 19#	3 Ring • 4-1/4" x 12-1/4" long - mounts under deck
88008 (12 pcs per pkg) 24#	4 Ring • 4-1/4" x 16-1/4" long - mounts under deck
88009 (20 pcs per pkg) 49#	5 Ring • 4-1/4" x 20-1/2" long - mounts under deck
88010 (12 pcs per pkg) 12#	2 'S' shape • 4-1/4" x 8-1/4" long - mounts under deck
88004-1 (12 pcs per pkg) 27#	2 double ring • 4-3/4" x 9-1/2" long - mounts under deck
88006-1 (12 pcs per pkg) 17#	3 Ring triangle • 8-1/2" x 8-1/2" - mounts above deck

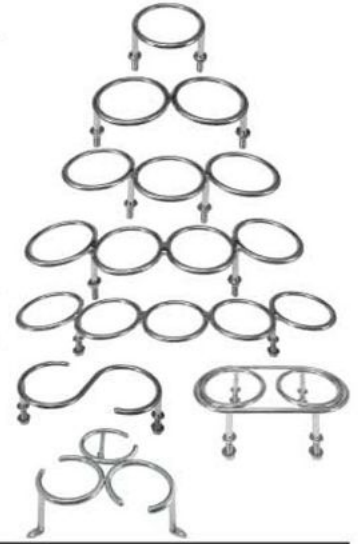

1-RING DRINK HOLDER - Top Mount

88002-1 (20 pcs per pkg) 14#	4-1/4" Ring x 4-1/8" x 1-3/4" high
88002-M	4-1/4" Ring x 2-3/4" high w/cup cutout



DRINK HOLDER - 316 SS - 3/8" Solid Cast Face

88004-3	2 Ring • 4 Legs • Ring: 3-3/8" I.O.
(12 pcs per pkg) 20#	4-1/8" x 8-5/8" x 2-3/4" - mounts under deck
	1-1/2" Threads with locknut/washer
88004-4	Same as above except mounts above deck
(12 pcs per pkg) 18#	



BOTTLE HOLDERS - LIQUOR/WINE - 316 SS 3/8" Solid Cast Face

88006-2	3 Ring • 2 Legs • Ring: 3-15/16" I.O.
(12 pcs per pkg) 20#	8" x 11-1/8" x 4" above deck
	1-1/2" Threads with locknut/washer



FORGED TRAILER BALLS CARBON STEEL CHROME PLATED

89050 (24 pcs per pkg) 43#	1-7/8" ball - 3/4" x 2" long • Load 2000 lbs.
89055 (24 pcs per pkg) 50#	2" ball - 3/4" x 2" long • Load 3000 lbs.



NYLON MARINE FITTINGS

BIMINI HARDWARE

NEW NYLON - 180° UNIVERSAL DECK HINGE - Black

7438 2-1/2" long x 13/16" wide, 1-3/4" high
 (100 per box) 6# Drilled for #10 screws



NEW NYLON - HINGED JAW SLIDE - Black

7418-1B For 7/8" tube
 (100 per box) 8# Opens to fit over tube



(ALL NYLON 100 PCS PER BAG)

MOST NYLON IS AVAILABLE IN BLACK OR NATURAL (OFF WHITE)

(Please add "B" or "N" after part # when ordering)

INSIDE EYE END



7402 - 3/4" inside eye end 2#
 7417 - 7/8" inside eye end 2#

OUTSIDE EYE END

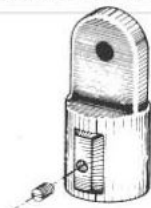

7419 - 7/8" outside eye end 4#
 7416 - 3/4" outside eye end 3#

JAW SLIDE



7418 - 7/8" jaw slide 7#
 7406 - 3/4" jaw slide 5#
 7418NB - for Q.R. pin 6#

DECK HINGE



7405 - Large deck hinge 4#
 7405BD - Large deck hinge-Black
 Drilled for Q.R. pin 3#
 7405BS - Large deck hinge-Black
 Tapped for 1/4-20 4#
 7428 - Large deck hinge/angled 4#
 7428 BD - Large deck hinge/angled-
 Black - Drilled for Q.R. pin. 28#

SIDE MOUNT/SLIDE



7424 - Side mount/slide fits 1.050 track 4#
 7430 - Side mount/slide fits .850 track 4#
 (jammer available)

JAMMER

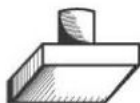

7411 - For locking 7424 and 7430
 in place. 1#

SLIDE LOCK



7432 - Slide lock for .850 track with
 fillister head screw 2#

SIDE MOUNT



7415 - 2-hole side mount 3#

DECK HINGE



7401 - Small deck hinge 3#

TRACK SLIDE

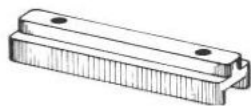

7408 - Track slide for deck hinge.
 Fits .850 track. 1#

DECK HINGE SLIDE COMBINATION

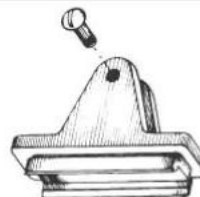

7431 - Deck hinge slide combination.
 Fits .850 track. 5#

DECK HINGE LOCK



7445L (left) / 7445R (right) -
 Deck hinge slide lock combination.
 Fits .850 track #6410 page 45. 7#

NYLON MARINE FITTINGS

BIMINI HARDWARE (continued)

Most Nylon available in black or natural colors.

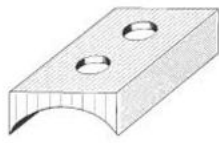
<p>SIDE MOUNT</p>  <p>7427 - 4 hole side mount 3#</p>	<p>INSIDE EYE END</p>  <p>7473 - 3/4" inside eye end 90° 3#</p>	<p>QUICK RELEASE PIN</p>  <p>7513 - Quick Release Pin 1#</p>	<p>EYE END BRACKET</p>  <p>7475 - 3/4" 90° inside eye end bracket 3#</p>	
<p>END EYE ADJUST</p>  <p>7474P - Port adjust bracket 8# 7474S - Starboard adjust bracket* intended to adjust 3/4". 90° inside eye. (Black Only) 2#</p>	<p>NYLON HEAD SCREW</p>  <p>7424P - Plastic head 1/4"-20 screw. Fits all SS side mounts and deck hinges.</p>	<p>NYLON HEAD SCREW</p>  <p>7523 - Large Plastic Head 1/4" - 28 x 3/4" 3#</p>	<p>1" SQ. JAW SLIDE</p>  <p>7515 - 1" sq. jaw slide. 7#</p>	
<p>1" SQ. INSIDE EYE END</p>  <p>7516 - 1" sq. inside eye end 4# Black Only</p>	<p>1" SQ. OUTSIDE EYE END</p>  <p>7517 - 1" sq. outside eye end 5#</p>	<p>RAIL HINGE ADAPTER</p>  <p>7444 - Rail hinge adapter 2#</p>	<p>DECK HINGE WEDGE</p>  <p>7530 - Deck hinge wedge 5° 1#</p>	
<p>LASH HOOK</p>  <p>7420 - 2-hole lash hook 1#</p>	<p>EYE STRAP</p>  <p>7407 - Eye Strap 1#</p>	<p>LASH HOOK</p>  <p>7460 - 1-hole lash hook. 1#</p>	<p>SET SCREW - For Nylon Canvas Hardware</p>  <p>7200 - 1/4-20 X 1/4" cup point Fits 3/4" & 7/8" jaw slides and eye ends (100 pcs per pkg) 3#</p>	<p>SHOULDER SCREW For Nylon</p>  <p>7201 - Fits 3/4", 7/8" Nylon Jaw Slides and Deck Hinges (100 pcs per pkg) 4#</p>
<p>3/4" JAW SLIDE</p>  <p>7522 - 3/4" Jaw Slide 3#</p>	<p>SLIDE BRACKET</p>  <p>7525 - 4 1/2" Slide bracket. Used with 7522. 2#</p>	<p>SLIDE BRACKET</p>  <p>7527 - 2 1/4" Slide Bracket. Used with 7522. 2#</p>	<p>RAIL HINGE</p>  <p>7443 - Hinge for 7/8" rail. 3#</p>	

NYLON MARINE FITTINGS

Most Nylon available in black or natural colors.

WINDOW SPACER

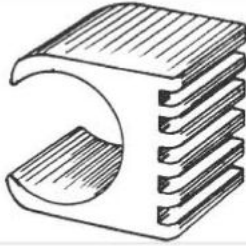

7628 - 7/8" Window spacer - white 3#

7629 - 1" Window spacer - white 3#

7628G - 7/8" Window spacer - gray 3#

COMBINATION WINDOW SPACER / BOAT TOP FRAME LOCK

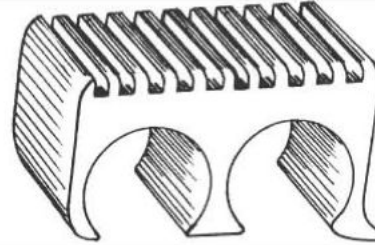

7630 - Window Spacer and Boat Top Frame Lock for 7/8" Tubing - white 5#

TRACK TRIM ENDS

CHANNEL END CAP

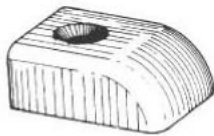

7404 - Channel trim end cap. Fits over .850 track. 1#

CHANNEL END CAP

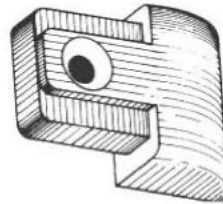

7429 - Channel trim end insert. Fits .850 track. 1#

CHANNEL END CAP

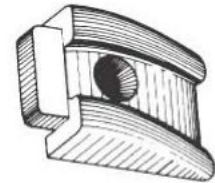

7422 - Channel stop end cap. Fits 1" track. 1#

GUNNEL TRIM END

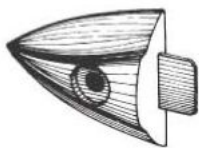

7425 - Gunnel molding trim end 1-1/8" 2#

7409 - Gunnel molding trim end 1-1/4" 2#

GUNNEL TRIM END

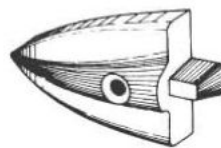

7410 - Gunnel molding trim end 15/16" 2#

7486 - Gunnel molding trim end 1-7/16" 2#

TRIM END

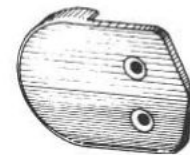

7600 - Trim end for 2". Soft or hard material. 3#

1-1/4" GUNNEL MOLDING END CAP



7498 - 1-1/4" Gunnel molding. End cap. 2#

SLIDE KIT



7440 - Slide kit. 10#

BOW RAIL SOCKET

Fits 7/8", 1"
O.D. Tube

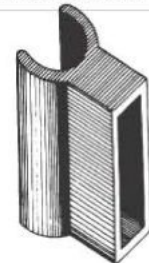

7512 - Bow Rail Socket
7/16"x 2-9/16" I.D. 4#

NYLON MARINE FITTINGS

TUBE-STANCHION HARDWARE

Most Nylon available in black or natural colors.

TUBE CONNECTOR



7456 - 7/8" tube connector 4#

7448 - 3/4" tube connector 4#

STAND OFF

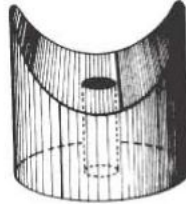

7491 - 1/2" stand off for 7/8" tube 2#

1" GUNNEL MOLDING END CAP

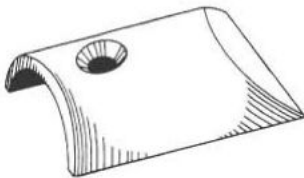

7489 - 1" Gunnel molding. End cap. 2#

BATTEN SOCKET

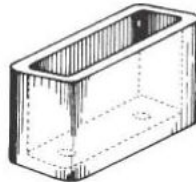

7434 - 2-hole batten socket 2#

CHOCKS

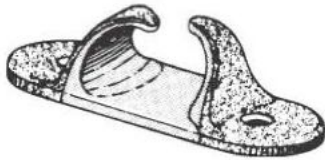

7455 - Skene bow chocks - pair.

3-1/2" long #8 screw. Etched finish.

58# Per Pair

CLEATS



7439 - 8" cleat for 5/8" for 1" rope - 5/16" studs.

.252#

7442 - 10" cleat for 1" rope 5/16" studs.

Etched finish. 38#

CLEATS



7433 - 4-1/4" cleat for 5/16" rope - 3/18" studs .059#

7421 - 6" cleat for 7/16" rope - 1/4" studs. Pull-tested by Tropical Marine Testers, Inc. and found to exceed strength of s/s fasteners. 14#

ROD HOLDER



7447 - Flush mount rod holder. 1-5/8" ID to 9-1/2" length. 3-1/2" x 4-1/4" flange dia. Etched finish - 1-piece construction. Available black or white.

.150#

LIFT-N-LAY MOUNT

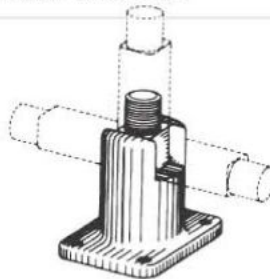

7003 - Marine Antenna Lift-N-Lay Mount. Includes 4 angled shims per mount. Manufactured from hi-impact super tough nylon

(ferrule & adaptor available). 18#

RATCHET MOUNT

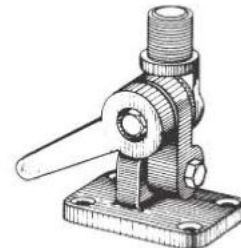

7001 - Marine Antenna Ratchet Mount. All s/s 3/8" nut-bolt hardware. 60#

NYLON MARINE FITTINGS

MISC. HARDWARE (continued)

Most Nylon available in black or natural colors.

3" CUP HOLDER

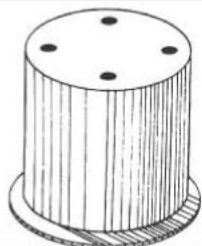

7511 - 3" cup holder - 2-7/8" deep 10#

7510 - 3" cup holder - 1-7/8" deep 8#

7514 - 3" cup holder - 1-1/2" deep 7#

FERRELL

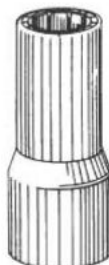

7264 - Ferrell 4#

7264H - Ferrell .458" hole 4#

REDUCER ADAPTOR

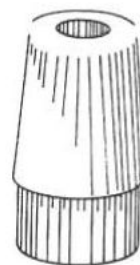

7188 - 1/2" Core Reducer Adaptor 4#

7189 - 3/8" Core Reducer Adaptor 4#

TRAILER BUSHINGS

ROLLER BUSHING

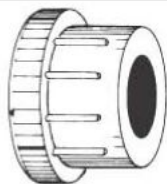

7355 - Roller bushing 1/2" shaft .875 OD 2#

7358 - Roller bushing 1/2" shaft 1.175 OD 2#

ROLLER BUSHING

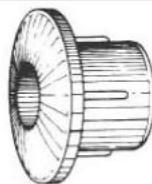

7359 - Roller bushing 5/8" shaft 1.185 OD 2#

7350 - Roller bushing 5/8" shaft .770 OD 2#

ROLLER BUSHING

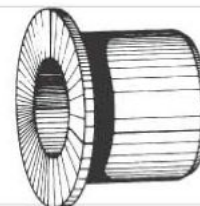

7351 - Roller bushing 1/2" shaft .760 OD 3#

ROLLER BUSHING

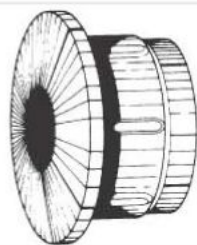

7353 - Roller bushing 5/8" shaft 1.465 OD 3#

7352 - Roller bushing 5/8" shaft 1.075 OD 3#

SHACKLE BUSHING



7356 - Shackle bushing 1/2" shaft .980 OD 2#

7357 - Shackle bushing 9/16" shaft .860 OD 2#

SHACKLE BUSHING

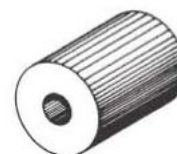

7354 Shackle bushing .480 ID - .870 OD 2#

7360 Shackle bushing 1/2" shaft .865 OD 2#

WINDSHIELD HARDWARE

WINDOW BRACE TUBE

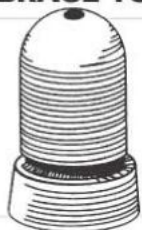

7504 - Window brace tube-insert goes with 7480

A & C. Use with 7480. 3#

BRACE FOOT

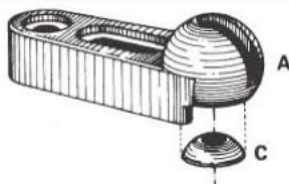

7480 - Adjustable windshield foot fits 5/8" tube -

2 piece A and C. Use with 7504. 3#

NYLON MARINE FITTINGS

WINDSHIELD HARDWARE (continued)

Most Nylon available in black or natural colors.

BRACE FOOT

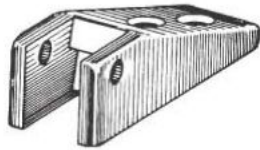

7403 - Windshield brace foot. Fits 1/2" square tube. 2#

RETAINER SPACER

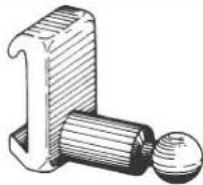

7413 - Windshield spacer/retainer male. 3/4" stand off. 3#

STAND OFF

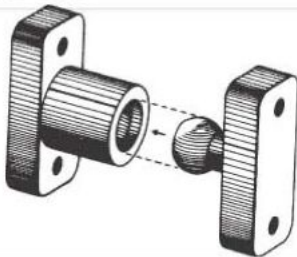

7500 - 1/2" ball and socket stand off 2#

SINGLE WING WINDSHIELD LATCH



7501 - Stands off .105 - flush hole 1#
 7251 - Stands off .250 - recessed hole 1#
 7290 - Stands off .290 - recessed hole 1#
 7300 - Stands off .300 flush hole 1#
 7370 - Stands off .370 - flush hole 1#

BUMPER

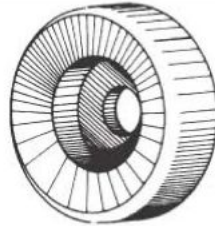

7168 - Bumper .725 diameter.
 Windshield/window/door. 1#

RETAINER



7412 - Windshield retainer male. 1/4" stand off. 1#

SIDE VENT ADJUSTER

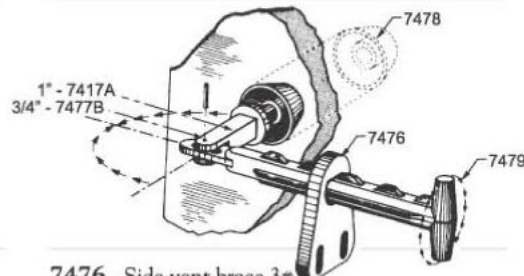

7476 - Side vent brace 3#
 7477A - Long insert (1") 3#
 7477B - Short insert (3/4") 3#
 7478 - Side vent insert retainer cap 3#
 7479 - Side vent adjust handle (notched) 4#

DOUBLE WING WINDSHIELD LATCH

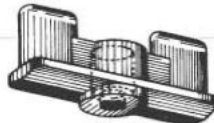

7222 - Double wing windshield latch. 1#
 Stand off .022 - recessed hole.
 7750 - Windshield loop latch. 1#
 Stands off .225 - flush hole.

RETAINER



7465 - Windshield retainer female.
 2-hole, length 1.375" 2#

RETAINER



7414 - Windshield retainer female. 2#

SIDE VENT ADJUSTER

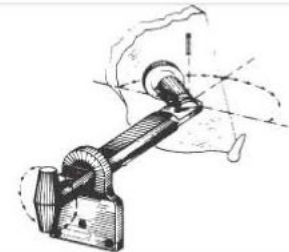

7470 - Side vent brace 2#
 7471 - Side vent pin 2#
 7472 - Side vent adjust handle (oval) 2#

THUMB WINDSHIELD LATCH



7035 - Windshield thumb latch.
 Stands off .035 - flush hole. 1#
 7062 - Windshield turn button. Stands off .065 -
 flush hole. Flush turn buttons available upon request.
 1#

NYLON MARINE FITTINGS

VENT-DRAIN HARDWARE

Most Nylon available in black or natural colors.

HOSE ADAPTOR



7459 - Collector box hose adaptor. Secures 3" hose to collector box. 2#

COLLECTOR BOX



7451 - Collector box for #7446 or #7458 vent. Accepts 3" and 4" hose. 43#

DRAIN

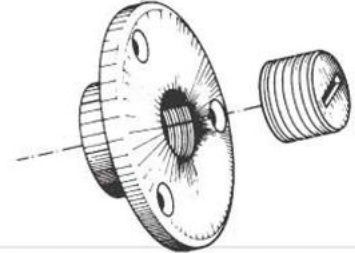

7435 - Garboard drain and plug. Threaded plug with slot. 3#

THRU-HULL DRAIN

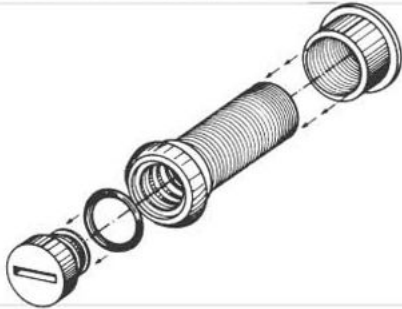

7426 - Thru-hull drain assembly. Serrated press fit installation. 3#

SINGLE FUNNEL



7436 - Sink funnel drain. Fits 3/4" hose. 2#

MISCELLANEOUS TAIL SLIDE



7490 - Sew-in curtain track retainer. 1#

LOUVERED VENTILATOR



7446 - Louvered ventilator 17-1/4" x 2-1/2" x 1-1/2" dimension B.I.A. Certified available with chrome finish 27#

ZEBRA VENTILATOR



7458 - Zebra Ventilator 48#

LARGE COLLECTOR BOX



7494 - Large collector box for #7495. Fits 3" and 4" hoses. 43#

COCKPIT SCUPPER

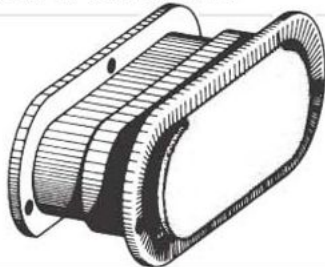

7492 - Cockpit scupper. 1-3/4" - 3-1/2" variable transom thickness 1-3/8" x 5" opening. 2-1/4" x 6" outer flange. Sole of inner flange flush with deck. 3-piece assembly - soft flapper. 17#

ADJUSTABLE SUPPORT POLE HARDWARE

SUPPORT POLE HARDWARE - BLACK NYLON



7619 / 7620



7621 / 7624



7621NS



7610 / 7622



7623/7521



89008



7524B

7610	Pole end 7/8" fits 2" grommet	2#
7619/7619W	Rubber foot 3/4" Black/White	2#
7620/7620W	Rubber foot 7/8" Black/White	3#
7621	Pole end 3/4" with SS snap	3#
7621NS	End cap 3/4"	2#
7624	Pole end 7/8" with snap	3#
7622	Pole end 3/4" fits 2" grommet	3#
7623	Jointer section 3/4" to 7/8"	5#
7521	Jointer section 7/8" to 1"	7#
7524 B	Replacement adjuster screw for 7623/7521	.013#
89008	SS Internal Spring button stop	2#

SUPPORT POLES 3/4" / 7/8"

3636 (25 pcs per pkg) 25# Adjustable support pole 40" to 70" Anod. Fin.

3436-0 (25 pcs per pkg) 25# Adjustable support pole 40" to 70" Mill Fin.

4848 (25 pcs per box) 34# Adjustable support pole 48" to 96" Anod. Fin.

Each unit is equipped with 3 end fittings, 7619, 7622 and 7621



Special sizes available upon request.

MARINE HARDWARE



ALUMINUM

4352 3# Arm Support (pairs)



ALUMINUM

4347 1# Helms Seat Hinge - Regular 8" x 10" (pairs)

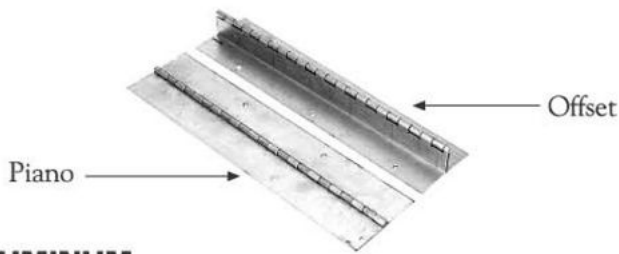

ALUMINUM

- 4650 2# Offset Hinge - Mill 6' lengths x 2-1/2" as shown
- 4649 1.4# Piano Hinge - Mill 6' lengths x 3" widths as shown
- 4647 .987# Piano Hinge - Mill 6' lengths x 2" widths as shown
- 4647-1 .17# Piano Hinge E- Mill lengths x 2" wide

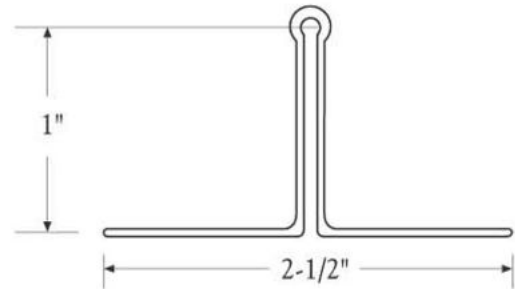

ALUMINUM

		Length	Pcs	Box
6410	TM-5 Small Track - .850 anodized	14'	25	68#
6421	Awning Rail A-15 - 135° anodized	16'	25	50#
6422	Awning Rail A-15 - 135° mill	16'	25	50#



		Length	Pcs	Box
6028	Plastic Awning Rail - White	8'	15	24#
6029	Plastic Awning Rail - Black	8'	15	24#
6022	Vinyl Awning Extrusion - Black	100'	Per Box	8#
6024	Vinyl Awning Extrusion - White	100'	Per Box	8#



UNIVERSAL BOAT TOP FRAMES READY TO ASSEMBLE KIT FORM

STANDARD 2-BOW FRAME

7/8" x 058 DRAWN ALUM. BRITE ANODIZED ROUND TUBE

4850	6#	Nylon hardware Natural
4850-B	6#	Nylon hardware Black
4850-D	8#	Die cast hardware - Chrome

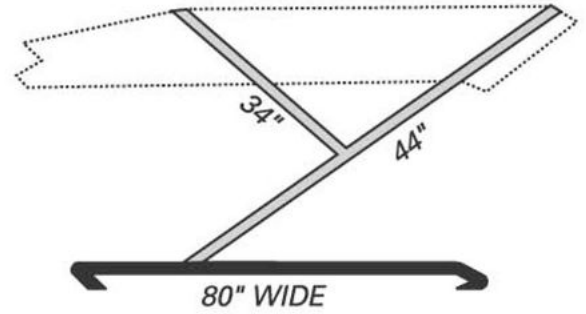

EXTRA LARGE STANDARD 2-BOW FRAME

7/8" x 058 DRAWN ALUM. BRITE ANODIZED ROUND TUBE

4855	10#	Nylon hardware - Natural
4855-B	10#	Nylon hardware - Black
4855-D	11#	Die cast hardware - Chrome

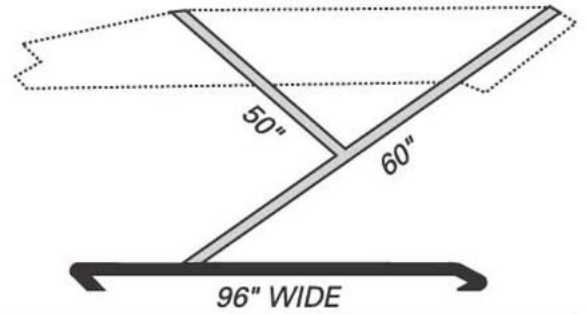

BIMINI 3-BOW FRAME

7/8" x 058 DRAWN ALUM. BRITE ANODIZED ROUND TUBE

4851	13#	Nylon hardware - Natural
4851-B	13#	Nylon hardware - Black
4851-D	14#	Die cast hardware - Chrome

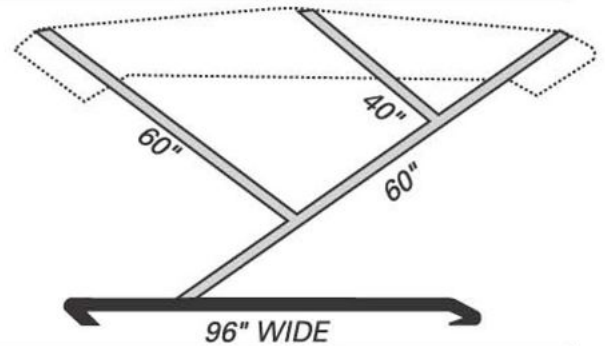

PONTOON BOAT FRAME

1 x 1 x 062 EXTRUDED SATIN ANODIZED SQUARE TUBE

4854	30#	Nylon hardware - Natural
------	-----	--------------------------

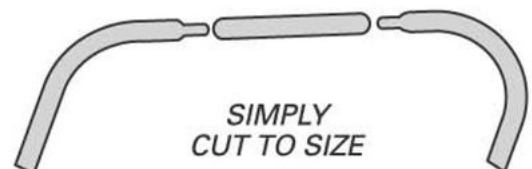
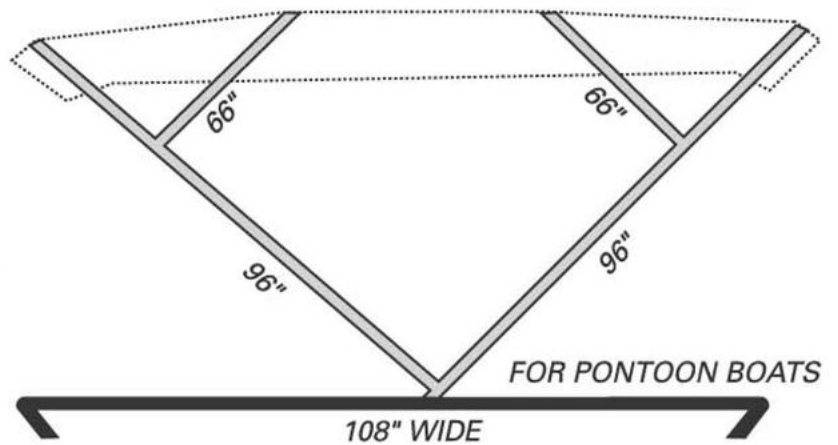

**The Nation's Largest Stocking Distributor
of Tubing and Fittings for the
Pleasure Boating Industry**



**Fax: 1-800- 283-6967
E-Mail: info@kingmarine.com
www.kingmarine.com**

WEST COAST DIVISION

3810 124th St. N.E.
Marysville, WA 98271-8775

KMI 2015

EAST COAST DIVISION

3476 Albemarle Church Rd.
Columbia, NC 27925